

ENGLISH

Please carefully read this operating instructions completely before commissioning the probe!
 Do not discard!
 The operator shall be liable for any damage caused by installation or operating errors!

	<p>Chlorine</p>	<p>CC1 (analog-out/analog)</p>	<p>analog signal output Dual power supply $\pm 5 - \pm 15$ VDC Single power supply 10 - 30 VDC Analog signal processing No galvanical isolation</p>
		<p>CC1 4-20mA (analog-out/analog)</p>	<p>analog signal output Current supply 4...20 mA Analog signal processing No galvanical isolation</p>

Content

	Page
1 General information	3
2 Function	3
3 Intended use	3
4 Scope of supply	4
4.1 CC1 (analog-out/analog) – 4-20mA with 5-pole M12	4
4.2 CC1 4-20mA (analog-out/analog) with 2-pole terminal	4
5 Preparation of the sensor for start up	4
6 Insertion of the sensor in the flow chambers FLC.....	5
6.1 Mounting with retaining ring.....	6
6.2 Mounting without retaining ring.....	6
7 Startup of the sensor.....	7
8 Control of the probe / Analytics.....	7
8.1 Sensors with 2-pole terminal + CE-mark (4-20mA).....	7
9 Disassembling of the sensor.....	7
10 Maintenance of the sensor	8
10.1 Change of electrolyte.....	8
10.2 Change of membrane cap	8
11 Storage	9
12 Electrical specifications	9
12.1 CC1 (analog output, analog internal signal processing).....	9
12.2 CC1 4-20 mA (analog output, analog internal signal processing).....	9
12.2.1 Electrical connection: 2-pole terminal.....	10
12.2.2 Electrical connection: 5-pole M12 plug-on flange.....	10
13 Technical data	10
14 General operating guidelines.....	12
15 Spare parts	12
16 Trouble Shooting	12
16.1 General Troubleshooting.....	13
16.2 Special troubleshooting for sensor	14
17 Warranty	16
18 Liability disclaimer.....	16

1 General information

The chlorine sensor CC1 is a special sensor to measure the free chlorine concentration in waters which contain iso-cyanuric acid (swimming pool water or drinking water). The sensor signal is independent from the concentration of iso-cyanuric acid. The sensor has a low dependance of pH-value, so fluctuations of the pH value have only a small influence on the sensor signal. The sensor should only be used in water qualities of potable water!

By usage of the special electrolyte ECP2S/GEL the chlorine sensor can be used in sea water.

This sensor is not suitable to check the absence of chlorine.

A complete measuring and/or control system normally consists of the following components:

- sensor
- electrical leads and connectors
- flow chambers and connections
- measuring and control device
- dosing equipment
- analysing instrumentation

This operating instructions primarily refers to the sensor. Please pay attention to the corresponding operating instructions of the peripheral devices!

Warning: *Do not touch the electrode finger and keep it clean!
Do not remove the layer on the electrode finger!*

2 Function

The chlorine sensor is a membrane covered potentiostatic 3-electrode system, with a specially placed counter electrode. The measuring electrode is membrane covered and is in the electrolyte area together with the reference electrode. This electrolyte area contains a special electrolyte and is separated from the measuring water.

In this measuring method chlorine diffuses out of the measuring water, through the membrane and causes in compound with the electrolyte an electrical signal at the measuring electrode. This method is patented. The electrical signal at the measuring electrode is proportional to the chlorine concentration and is amplified by the electronics of the sensor. The measuring signal is independent from the temperature of the measuring water due to an integrated temperature compensation.

3 Intended use

The sensor has to be inserted in the flow chambers type FLC according to this operating instructions (see item 6). The use of the sensor in other flow chambers has to be released by the manufacturer of the sensor. Otherwise the liability for a proper function of the sensors and personal injury and damage to equipment resulting from that is disclaimed.

The maximum allowed operating pressure of the sensor is 0.5 bar / 5 mwc. The allowed temperature operating range of the sensor is 0 up to <45 °C. Further operating guidelines see items 12 + 13. The sensor is to be used only for the measurement and control of the concentration of total chlorine.

Only trained and authorised staff should operate the sensor.

Each application beyond this is a not intended use so the warranty becomes void and the liability is disclaimed.

We do not accept liability for injury to persons or damage to property if the operating instructions in this manual have not been followed, or the original state of the sensor has been changed, or the sensor has been used under conditions other than those specified.

If installing the sensor outside Germany, please comply with the corresponding local regulations.

4 Scope of supply

Keep the packaging for the sensor completely. In case of repair or warranty return the sensor in this package.

Check that the delivery is intact. In case of damage please contact your supplier.

Check that the delivery is complete by comparing with the below mentioned scope of supply.

4.1 CC1 (analog-out/analog) – 4-20mA with 5-pole M12

- 1 sensor with membrane cap M48.2
- 100 ml gel-electrolyte ECC1/GEL
- 1 piece of abrasive paper S1
- 1 operating instructions

4.2 CC1 4-20mA (analog-out/analog) with 2-pole terminal

- 1 sensor with membrane cap M48.2
- 1 mA-cap with o-ring 20 x 1.5
- 100 ml gel-electrolyte ECC1/GEL
- 1 piece of abrasive paper S1
- 1 operating instructions

5 Preparation of the sensor for start up

Attention:	<i>GEL-electrolytes are not allowed to be shaken! After opening store them head first on the closing cap!</i>
Safety hint:	<i>Some electrolytes contain diluted acids. Please heed the warnings on the electrolyte bottle. Do not swallow the electrolyte. Avoid contact of the electrolyte with skin and eyes. Otherwise wash with a lot of water. In case of eye inflammation, contact a doctor.</i>
Hint:	<i>To rinse the residuals of GEL-electrolytes from the electrode finger and the membrane cap the use of warm water is recommended.</i>

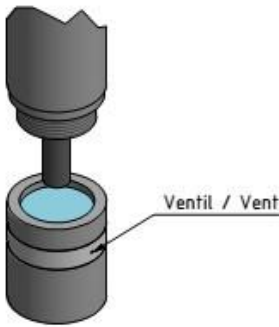
	<p>Pull the transparent protection cap off the membrane cap. The sensor is delivered with the membrane cap loosely screwed on the electrode shaft. Unscrew the membrane cap from the electrode shaft. Place the membrane cap onto a clean base. Fill up the membrane cap up to the edge with the enclosed electrolyte. Be careful so that there are hardly no bubbles in the electrolyte. Then replace it onto the base.</p>
	<p>Hold the electrode shaft upright and put it on the filled membrane cap. Then screw the membrane cap onto the electrode shaft. Turn it anticlockwise until the thread engages, then screw slowly the electrode shaft clockwise (by hand) onto the membrane cap. Excess electrolyte will escape through a valve (located above the type marking) in the membrane cap. Do not close this vent (see arrow) with your finger.</p> <p>Warning: Electrolyte may spurt from the vent. Excess electrolyte or electrolyte which gets on your skin or in your eye wash up with water. Some electrolytes contain diluted acids. Please heed the warnings on the electrolyte bottle.</p> <p>Make sure that the membrane cap is tightly fastened to the electrode shaft! Wash up the excess electrolyte with water.</p>

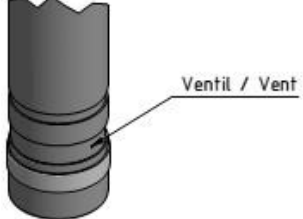
	<p>Important: Check whether the membrane cap is completely screwed in up to the stop. The first screw-in resistance comes from the O-ring seal; however, the screwing procedure of the cap must be continued until it hits the electrode shaft! When the membrane cap has been screwed on, the membrane is curved to the outside and must not be thumped any more, as this will damage the membrane and thus make it unusable.</p> <p>Caution: When the filled membrane cap is completely screwed onto the electrode shaft it is not allowed to touch or to adjoin the membrane!</p>
	<p>Important: When you unscrew the membrane cap do not forget to lift up the hose ring that covers the vent. So air is allowed to stream into the membrane cap. Otherwise the membrane will be destroyed because of the vacuum building up in the membrane cap.</p>

6 Insertion of the sensor in the flow chambers FLC

Depressurise the system before inserting the sensor into the flow chamber type FLC. Close the stop valves before and after the flow chamber.

Insertion of the sensor into the flow chamber should be carried out slowly.

The sensor is not allowed to be pushed against the bottom of the flow chamber!

Warning: A sudden failure of the sensor may lead to a very dangerous overdosing of the disinfectant – please provide preventative measures. Check the equipment for the smell of chlorine, and the water for abnormal colour. In case of a very high overdose, the DPD-1 measuring may remain colourless, as the colorant will be bleached by the disinfectant.

Recommendations: Install a control unit with dosage time monitoring, orp measuring as safety measuring with limit value monitor and alarm switch. Any dosage made for drinking water should only be made in proportion to the volume; the measuring value may be applied as a disturbance.

Caution: Max. operating pressure of the sensor 0.5 bar (5 mwc).

Operating mode	Flow chamber	Operating pressure max.	Operating temperature max.	Flow rate l/h
IMPORTANT:	!! Heed and comply with the max. allowed operating pressure / operating temperature of the sensor !!			
Operation of the sensor without retaining ring	FLC-1	0.5 bar (5 mWS)	45 °C	15 (45)
	FLC-3		70 °C	45 (15)
Operation of the sensor with retaining ring	FLC-1	4.0 bar (40 mWS)	45 °C	15 (45)
	FLC-3	8.0 bar (80 mWS)	70 °C	45 (15)

6.1 Mounting with retaining ring

For the installation of the sensor in the flow chamber the sensor can be equipped with retaining ring, slide-ring and O-ring by the manufacturer (see fig. 1). For installation of the sensor in the flow chamber unscrew the 1 ¼” screw-connection from the flow chamber. Prepare the sensor according paragraph 5. Make sure that retaining ring, slide-ring and O-ring are properly fixed according fig. 1.

Fig. 1:

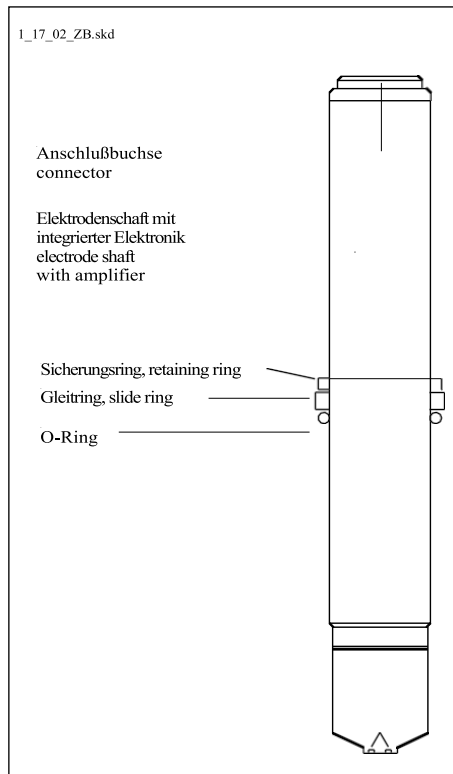
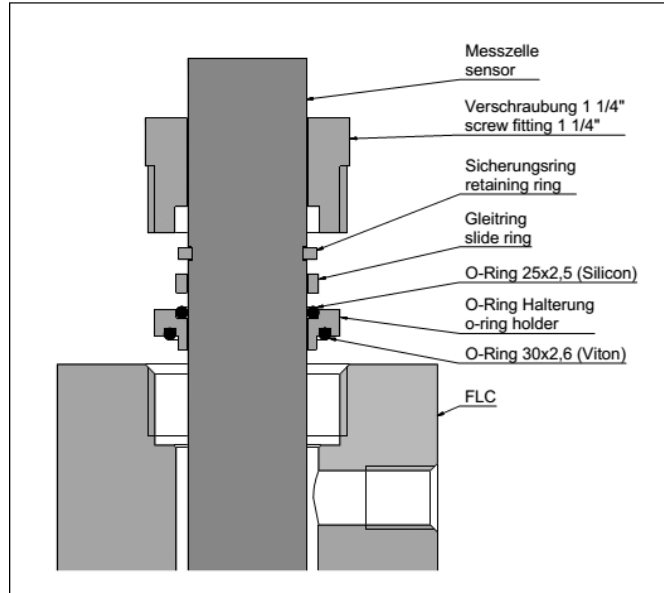

Fig. 2:



Insert the sensor according fig. 2 into the flow chamber. Push the earlier unscrewed 1 ¼” screw-connection carefully over the inserted sensor and fasten it tightly, otherwise leaks may occur.

First open the measuring water outlet. Then open slowly the measuring water supply. Avoid installations that allow air bubbles to enter the measuring water.

6.2 Mounting without retaining ring

If the sensor is not equipped with retaining ring, slide-ring and o-ring it can also be installed in the flow chamber by using an o-ring and 2 slide rings. The second slide ring has to be used instead of the retaining ring. Loosen the 1 ¼” screw-connection of the flow chamber. Insert the sensor (after preparation according paragraph 5) into the flow chamber until the distance between the membrane and the inflow-opening is approx. 2 cm. Fasten the 1 ¼” screw-connection tightly. Please make sure that the sensor is tightly fastened in place, otherwise it may be pressed out of the flow chamber when it is under pressure and / or leaks may occur.

First open the measuring water outlet. Then open slowly the measuring water supply. Avoid installations that allow air bubbles to enter the measuring water.

7 Startup of the sensor

Connect the sensor with the measuring device.

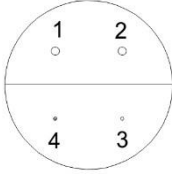
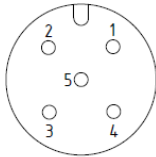
<p>Connection of sensors with 0...+/-2000 mV signal output</p>	<p>4 pole connector, reverse polarity protection, symmetrical or unipolar power supply pin configuration: 1 (socket) +U 2 (socket) -U or voltage GND 3 (PIN) GND or Signal GND 4 (PIN) signal output</p>	
<p>Connection of mA-sensors with 2-pole terminal</p>	<p>2-pole terminal clamp Push the sensor cable through the black cable gland of the cap. Then fasten the wires in the terminals of the sensor electronics. By hand, screw the cap only now onto the sensor body/shaft until the o-ring seals. Now tighten the black cable gland (fixing the cable). For disconnection untighten the black cable gland first to release the cable. Recommended cable: diameter approx. 4 mm, 2 x 0.25 mm².</p>	
<p>Connection of mA-sensors with 5-pole M12 plug-on flange</p>	<p>5 pole screw-connector, M12, reverse polarity protection pin configuration: PIN 2: +U PIN 3: -U</p>	

As a rule the sensor is run in after about 2 hours so that a first adjustment can be made. The adjustment has to be repeated after approx. one day.
For proper function of the sensor the slope adjustment has to be repeated in regular intervals.

8 Control of the probe / Analytics

A balance or checking of the sensor using **DPD-1 method** ("free chlorine") should be performed regularly depending on utilization.

Recommendation: weekly check, if necessary more frequently.

The analytically determined value is adjusted by means of slope calibration function of the measuring and/or control device (see operation manual of the device).

It is recommended to replace the electrolyte every 3 - 6 months.

8.1 Sensors with 2-pole terminal + CE-mark (4-20mA)

Factory provided the potentiometer sideways to the 2-pole-connector is adjusted on the measuring range which is specified on the label. This adjustment is secured by a sealing wax. The setting of the potentiometer should not be changed.

9 Disassembling of the sensor

Switch of secondary measuring and/or control systems or switch them to manual operation before dismantling the sensor. A disassembled sensor results in an incorrect measuring value, which may cause an uncontrolled dosing within a control system.

Lock the measuring water supply and the outlet. Disconnect the sensor from the device.

Disconnection of sensors with 2-pole terminal: First untighten the PG screw-connection so that the cable is released. Unscrew the cap from the sensor. Then disconnect the wires from the 2-pole-terminal.

Untighten the screw-connection and pull out the sensor carefully.

10 Maintenance of the sensor

Caution: *The brown coating of the electrode finger must not be emieried!!
Do not unscrew the metallic membrane holder from the cap as this will damage the membrane.*

Hint: *To rinse the residuals of GEL-electrolytes from the electrode finger and the membrane cap the use of warm water is recommended.*

Check the sensor regularly for dirt, algae and bubbles. As far as possible avoid contamination of the membrane with solid particles, deposits etc. Bubbles on the outside of the membrane can be eliminated by increasing the flow rate temporary.
A slope adjustment has to be made after a change of the membrane cap or the electrolyte.

10.1 Change of electrolyte

Recommendation: change the electrolyte every 3 – 6 months. And also, if an adjustment is impossible due to unstable or too low values displayed.

Lift the hose ring on the membrane cap above the type marking sealing the vent sideways so that the opening is free (see fig. 3). The membrane cap is unscrewed and then air streams into the uncovered vent. The electrode finger is cleaned with a clean, dry paper towel. With the special abrasive paper supplied just the tip of the dry electrode finger (= working electrode) is cleaned. Place the special abrasive paper on paper towel, hold it at one corner and rub the electrode tip of the perpendicularly held sensor two or three times across the abrasive paper (see fig. 4). Then replace the hose ring onto the vent and fill with electrolyte (see item 5).
If the sensor still displays unstable or too low values, a new membrane cap must be used.

10.2 Change of membrane cap

Recommendation: change of the membrane cap once a year. And also, if an adjustment is impossible due to unstable or too low values displayed.
Lift the hose ring on the membrane cap above the type marking sealing the vent sideways so that the opening is free (see fig. 3). The membrane cap is unscrewed and then air streams into the uncovered vent. The electrode finger is cleaned with a clean, dry paper towel. With the special abrasive paper supplied just the tip of the dry electrode finger (= working electrode) is cleaned. Place the special abrasive paper on paper towel, hold it at one corner and rub the electrode tip of the perpendicularly held sensor two or three times across the abrasive paper (see fig. 4). Take a new membrane cap and fill with electrolyte (see item 5).
If the sensor still displays unstable or too low values, a check / reconditioning by the manufacturer has to be done.

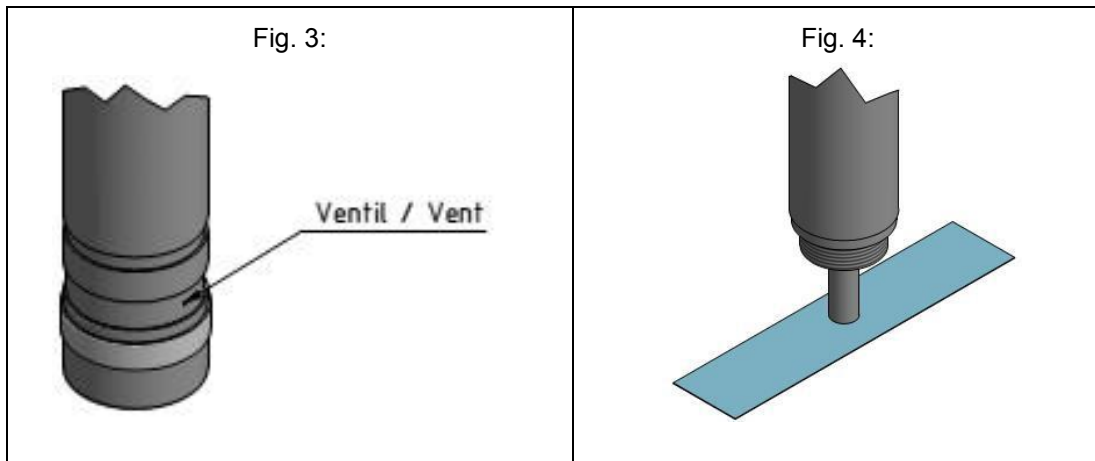

11 Storage

To store the sensor the membrane cap is unscrewed. Membrane cap and electrode finger are rinsed in clean water and dried in a place free of dust. The dry membrane cap is then loosely screwed onto the electrode shaft to protect the electrode finger. The membrane must not rest against the measuring electrode.

When putting the sensor back into use after storage, the electrode tip must be cleaned with the special abrasive paper and a new membrane cap must be used (see item 5).

Used membrane caps which have been in operation for at least 1 day cannot be stored and reused.

12 Electrical specifications

The measuring and/or control device must be galvanically insulated from other devices!

The sensors are only allowed to be operated with the specified voltage supply.



Ensure that the supply voltage of the measuring and/or control device is stable. Too low a voltage supply can cause incorrect measuring values, which may result in dangerous overdosing within a control system.

The sensors have to be operated potentialfree. A current flow between the sensors and the measuring water is not allowed. Therefore the measuring and control devices must be supplied with a galvanical isolation. When a 4-20 mA current loop is present a galvanical isolation can be achieved by using a isolating amplifier.

12.1 CC1 (analog output, analog internal signal processing)

analog-out / analog

A potential-free electrical connection is necessary as the sensor electronic is not equipped with a galvanical isolation.

	Measuring range in ppm	resolution in ppm	Output Output resistance	Nominal slope (at pH 7.2)	Voltage supply	Connection
	EMC-Testing DIN EN 61326-1 RoHS compliant					
CC1N	0.05...20.00	0.01	0...-2000 mV 1 kΩ	-100 mV/ppm	±5 - ±15 VDC 10 mA	4-pole screw connector
CC1H (replaces CC1HUn)	0.005...2.000	0.001		-1000 mV/ppm		
CC1Up	0.05...20.00	0.01	0...+2000 mV 1 kΩ	+100 mV/ppm	10 - 30 VDC 10 mA	



(Subject to technical changes!)

12.2 CC1 4-20 mA (analog output, analog internal signal processing)

Analog-out / analog



A potential-free electrical connection is necessary as the sensor electronic is not equipped with a galvanical isolation.

12.2.1 Electrical connection: 2-pole terminal

	Measuring range in ppm	resolution in ppm	Output Output resistance	Nominal slope (bei pH 7.2)	Power supply	Connection
		EMC-Testing DIN EN 61326-1 RoHS compliant				
CC1MA2	0.01...2.00	0.01	4...20 mA uncalibrated	8.0 mA/ppm	12...30 VDC R _L 50Ω...R _L 900Ω	2-pole terminal
CC1MA5	0.01...5.00	0.01		3.2 mA/ppm		
CC1MA10	0.01...10.00	0.01		1.6 mA/ppm		
CC1MA20	0.01...20.00	0.01		0.8 mA/ppm		

(Subject to technical changes!)

12.2.2 Electrical connection: 5-pole M12 plug-on flange

	Measuring range in ppm	resolution in ppm	Output Output resistance	Nominal slope (bei pH 7.2)	Power supply	Connection
		EMC-Testing DIN EN 61326-1 RoHS compliant				
CC1MA2-M12	0.01...2.00	0.01	4...20 mA uncalibrated	8.0 mA/ppm	12...30 VDC R _L 50Ω...R _L 900Ω	5-pole M12 plug-on flange Function of wires: PIN2: +U PIN3: -U
CC1MA5-M12	0.01...5.00	0.01		3.2 mA/ppm		
CC1MA10-M12	0.01...10.00	0.01		1.6 mA/ppm		
CC1MA20-M12	0.01...20.00	0.01		0.8 mA/ppm		

(Subject to technical changes!)

13 **Technical data**

Data sheets are available for each type of sensor!

Application	- with electrolyte ECC1/GEL: Swimming pool water, drinking water - with electrolyte ECC1S/GEL: sea water Surfactants (tensides) are partially tolerated.
Chlorination agents	inorganic chlorine compounds: NaOCl (=sodium hypochlorite), Ca(OCl) ₂ , chlorine gas, electrolytically generated chlorine and chlorine compounds based on isocyanuric acid (checked until 500 mg/L isocyanuric acid)
Measuring system	Membrane covered, amperometric potentiostatic 3-electrode system with electronic inside
Electronic	Analog version: - voltage output - not galvanically isolated electronics

	<ul style="list-style-type: none"> - analog internal data processing - output signal: analog (analog-out/analog) - current output analog - not galvanically isolated electronics - output signal: analog (analog-out/analog) - only valid for sensors with 2-pole-terminal & CE-mark: poti for (restricted) adjustment of measuring range
Information about the measuring range of sensors with 4-20 mA	<p>Slope of a sensor can vary production-related or application-related between 65% and 150% of the nominal slope</p> <p>-> Recommendation to determine the suitable measuring range or the suitable sensor: Concentration to be measured x factor 1.5 = measuring range of the sensor</p> <p>Example: Concentration to be measured 1.6 ppm x 1.5 = 2.4 -> recommended sensor with a measuring range of 5 ppm</p>
Slope drift At repeatability conditions (25 °C, pH 7,2 in drinking water)	approx. <-3% per month
indicator	Free chlorine
Working temperature	0 – <45 °C (no ice crystals in the measuring water)
Temperature compensation	Automatically, by an integrated temperature sensor
Max. allowed working pressure	0.5 bar, no pressure impulses and/or vibrations
Flow rate	approx. 15-30L/h in FLC-1, small flow rate dependence is given
pH-range	pH 4 – pH 12, highly reduced dependence on pH-value
Run-in time	First start-up approx. 2 h
Response time	T ₉₀ : approx. 2 min.
Zero point adjustment	Not necessary
Slope calibration	At the device, by analytical determination, DPD-1-Method
interferences	ClO ₂ is measured with 100 % O ₃ is measured
Connection	analog-out/analog version: 4-pole plug adapter 4-20 mA version: 2-pole terminal (2 x 1 mm ²) or 5-pole M12, plug-on flange (PIN2: +U, PIN3: -U)
material	Microporous hydrophilic Membrane, PVC-U, PEEK, stainless steel 1.4571
Size	diameter: approx. 25 mm Length: analog-out/analog version approx. 175 mm 4-20 mA version approx. 220 mm (2-pole-terminal) approx. 190 mm (5-pole-M12)
storage	Probe: Frost-protected, dry and without electrolyte no limit at >5 - <40 °C Membrane cap: used membrane caps cannot be stored!

	Electrolyte: in original bottle protected from sunlight min. 1 year at >10 - <35 °C
maintenance	Regularly control of the measuring signal, min. once a week The following specifications depend on the water quality: Change of the membrane cap: once a year Change of the electrolyte: every 3 - 6 months

(Subject to technical changes!)

14 General operating guidelines

- The sensor has to be operated in an upright position, so that the incoming flow comes from the bottom up to the membrane.
- During unpressurised operation with free outflow of the measuring water gas bubbles have no disturbing effect unless they cover the membrane. Gas bubbles at the membrane obstruct the inflow of the disinfectant, which leads to incorrect measuring signals.
- The dependence on the pH value is highly reduced compared to the previous chlorine measurement systems. When the pH-value increases one step the measuring signal decreases approx. 5 %. But avoid deposition of chalk.
- A minimum flow rate is necessary. The flow rate must be constant.
- The membrane life is typically one year, but can vary considerably depending on the water quality. Heavy contamination of the membrane should be avoided.
- Each sensor has been tested and the results are documented.
- During interval operation of the measuring system / plant the sensor is not allowed to be disconnected from the power supply. The sensor must be connected to the power supply all the time. The sensor must not be allowed to stand dry.
- The sensor is not allowed to be operated in chlorine free water for a longer period (>1 day).
Danger: build-up of sediments/contaminations (e. g. biological) on the membrane. This can interfere or block a later chlorine measurement.
After any operation without chlorine, run-in periods must be reckoned with. If required, switch on metering unit time-delayed.
If no chlorine is dosed for a longer period of time, the sensor must be disconnected from the device, disassembled and stored dry (see item 11).
- The presence of reducing-, oxidising reagents and corrosion inhibitors may interfere with the measurement.

15 Spare parts

membrane cap M48.2 (Art. No. 11047)
electrolyte ECC1/GEL, 100 ml (Art. No. 11005)

For sea water applications:
electrolyte ECC1S/GEL, 100 ml (Art. No. 11009)

16 Trouble Shooting

Trouble shooting must take account of the whole measuring circuit system from the extraction point to drain. In general, the measuring system consists of:

- sensor
- electrical leads and its connectors
- measuring and control device
- flow chambers with hose connections / pipe connections

16.1 General Troubleshooting

Fault	Possible Cause	Action
Sensor cannot be calibrated / deviation of the measuring value from DPD-measurement	Run-in time too short	See item 5, repeat calibration after several hours
	Membrane cracked	Replace membrane cap, see item 10.2
	Membrane cap damaged	Replace membrane cap, see item 10.2
	Interfering substances in the measuring water	Examine the measuring water for interfering substances and remedy, if necessary consult supplier
	Short-circuit / damage in the signal lead	Locate and eliminate short-circuit / defect, if necessary change the measuring cable
	Distance between working electrode and membrane is too great	Screw the membrane cap tightly onto the shaft until it hits the shaft
	DPD-chemicals spent	Use new DPD-chemicals, repeat calibration
	Deposits on the membrane	Replace membrane cap, see item 10.2
	Gas bubbles on the outside of the membrane	Increase the flow rate temporary, if necessary check installation and revise it
	Sensor defective	Return the sensor to the manufacturer for check/reconditioning
	No electrolyte in the membrane cap	Fill membrane cap with electrolyte and follow the instructions of item 5
Chlorine concentration exceeds the upper limit of the measuring range	Check the whole system, remedy fault, repeat calibration	
Measuring signal is not stable	Membrane cracked	Replace membrane cap, see item 10.2
	Bubbles in the electrolyte	Empty out the membrane cap and refill it carefully with new electrolyte without bubbles, see item 10.1
	Gas bubbles on the outside of the membrane	Increase the flow rate temporary, if necessary check installation and revise it

	Pressure fluctuations in the measuring water	Check installation, if necessary revise it
	Reference electrode exhausted and/or contaminated	Return sensor for reconditioning to the manufacturer
Only for MA-sensors: Output signal is 0	Sensor is connected to the measuring and/or control device with wrong polarity	Correctly connect the sensor to the measuring and/or control device
	Signal lead is broken	Replace signal lead
	Sensor defective	Return the sensor to the manufacturer for check/reconditioning
	Measuring and/or control device defective	Check the measuring and/or control device

16.2 Special troubleshooting for sensor

When the electrode finger turns shiny silver or white the sensor must be reconditioned by the manufacturer. Brown-grey or yellow-grey coloration is normal.

Tightness check of membrane cap	<p><u>Membrane cap M48.2 / M48.2G</u></p> <ol style="list-style-type: none"> 1. Thoroughly dry the outside of the membrane cap to be checked 2. Prepare membrane cap according to instruction manual and fill with electrolyte 3. Dry the outside of the membrane cap again if necessary 4. Slowly and carefully screw membrane cap on sensor according to the instruction manual 5. When screwing the membrane cap on, check if GEL leaks through the membrane <p>CAUTION: Thoroughly check if electrolyte leaks through the membrane or exits at the designated points. If necessary, repeat tightness check.</p> <p>-> If drop formation or dripping can be observed at the membrane, the membrane is damaged and a new membrane cap must be used. The forming of a small meniscus is ok since the membrane is hydrophilic.</p> <p>-> Check if the reference electrode was damaged by the exchange from measuring water to electrolyte. If it is not intact anymore, the sensor must be send back to the manufacturer for testing.</p>
Check of the electronic system (dry test)	<ol style="list-style-type: none"> 1. Unscrew membrane cap 2. Thoroughly rinse off electrode finger and dry carefully using clean cloth 3. Connect sensor to measurement/control device and wait for approx. 5 min. 4. Take readings of original sensor signal from measurement/control device or measure using a digital multimeter <ul style="list-style-type: none"> A) Sensor (mV): approx. +/- 0 mV B) Sensor (mA): approx. 4 mA C) Sensor (µA): approx. 0 µA <p>-> If the sensor signal approximately corresponds to the above mentioned values, the electronic system is likely to be ok.</p> <p>-> If the measured value significantly deviates from the above mentioned values, the sensor must be send back to the manufacturer for testing.</p>

<p>Zero point check</p>	<p><u>After the check of the electronic system</u></p> <ol style="list-style-type: none"> 1. Prepare sensor for start-up according to section 5 of the instruction manual 2. Connect sensor to measurement/control device 3. Place sensor carefully into a beaker filled with clean tap water (free from disinfectant!) 4. Stir for approx. 30 sec. using sensor in beaker (without causing air bubbles) 5. Then leave the sensor in the beaker and wait until the run-in time has passed (at least for 1 hour) 6. Take readings of original sensor signal from measurement/control device or measure using a digital multimeter 7. The sensor signal should approach zero. <p>-> If the sensor signal approaches zero, the zero point is likely to be ok. -> If the measured value deviates significantly from zero, maintenance must be carried out on the sensor according to section 10 of the instruction manual and the zeropoint check must be repeated. It has to be taken into account that a freshly cleaned working electrode (measuring electrode) has a relatively high zero point. The sensor needs a few days to reach its lowest zero point again. -> If the measured value does not approach zero even after maintenance was carried out, the sensor must be send back to the manufacturer for testing.</p> <p>Note: For sensors with very limited measurement ranges or high sensitivity, the zero points are always slightly above those of sensors with larger measurement ranges or low sensitivity.</p>
<p>Signal check</p>	<p><u>After zero point check</u></p> <ol style="list-style-type: none"> 1. Add some disinfectant to the beaker filled with clean tap water from section "zero point check" 2. Stir as steadily as possible using the sensor connected to the measurement device for at least 5 min. 3. During this time, you should observe an increase of the measuring signal <p>-> If the sensor signal increases, the sensor is likely to be ok. If the sensor does not react to the disinfectant, maintenance must be carried out on the sensor according to section 10 of the operating instructions and the "signal check" must be repeated. -> If the sensor still does not react to the disinfectant, the sensor must be send back to the manufacturer for testing.</p>
<p>Periphery check</p>	<p>e. g.</p> <ol style="list-style-type: none"> 1. Check flow 2. Check measuring cable 3. Check measurement/control device 4. Check proper calibration 5. Check dosing unit 6. Check concentration of disinfectant in the dosing tank 7. Check suitability of sensor for measuring the dosed disinfectant 8. Check concentration of disinfectant in the measuring water (analytics) 9. Check pH value of the measuring water 10. Check temperature of measuring water 11. Check pressure in the flow fittings 12. Check analytics

17 Warranty

We grant a manufacturer's warranty of two years on the electrode body including the electronics subject to appropriate application. The warranty does not apply to the membrane cap (wearing part), electrolyte (consumable material) and service work to be performed.

(Cleaning of the parts in contact with the electrolyte, renewing the silver chloride coating of the electrode finger and cleaning of the electrode tip with special abrasive paper). Should there be mechanical damage or should the serial number be illegible, the warranty becomes void.

Return of a sensor for check/reconditioning: Only shipments are accepted that are returned with carriage paid. Otherwise they will be returned to the sender.

On checked/reconditioned sensors we grant a warranty of one year on the electrode body including the electronics subject to appropriate application from the date of check/reconditioning. Should there be mechanical damage or should the serial number be illegible, this warranty becomes void.

18 Liability disclaimer

The sensors are manufactured with the greatest care and is subjected to a documented function test. Should any malfunctions occur in the sensor despite this, no liability claims may be lodged against the manufacturer in case of damage resulting from this malfunction.

Subject to technical changes!!

Potentiostatische 3-Elektroden Meßzelle
mit 4-poliger Anschlußbuchse
Potentiostatic 3-electrodes Probe with
4-pin Connector

10202.skd/ZB

Anschlußbuchse, vierpolig
connector, 4-pins

Elektrodenschaft
mit integrierter Elektronik
electrode shaft
with amplifier

Gegenelektrode
counter electrode

Bezugselektrode
reference electrode

Meßelektrode
working electrode

O-Ring 14 x 1,8 mm

Membrankappe
membrane cap

Ventilöffnung
vent

Membranscheibhalter
membrane disc holder

Membranscheibe
membrane disc



Potentiostatische 3-Elektroden-Meßzelle
in 4...20 mA - Ausführung
Potentiostatic 3-electrodes probe with
4...20 mA current loop

10302.skd/ZB

Pg7 - Verschraubung
fixing for cable

Haube
bonnet

2-polige Klemme
für Meßkabelanschluß
terminals for two wires

Elektrodenschaft mit
integrierter Elektronik
electrode shaft
with amplifier

Gegenelektrode
counter electrode

Bezugselektrode
reference electrode

Meßelektrode
working electrode

O-Ring 14 x 1,8 mm

Membrankappe
membrane cap

Ventilöffnung
vent

Membranscheibhalter
membrane disc holder

Membranscheibe
membrane disc

